



ASA Schalttechnik GmbH
F.-A.-Meyer-Straße 4
32457 Porta Westfalica
Germany

Phone: +49(0)571/97530-0
Fax: +49(0)571/9753080

www.asa-schalttechnik.com
info@asa-schalttechnik.de



Foot Switches

Made in Germany

ASA Schalttechnik – we drive the industry

Are you looking for reasonably priced technology that works smoothly, that fully meets your requirements and that offers a long service life with constant high performance as you would expect? And, on top of this, a range of products that is convincing in terms of both breadth and depth? Then we have the good news that you have been waiting for: At ASA Schalttechnik we do everything imaginable so that your wishes become reality.

Our team consists of doers, creative minds and service experts: Experienced professionals who live and breathe quality, who draw on unlimited resources on 2,000 m² production space, are dedicated to detail and who get to the heart of things when it comes to control and switching technology. Altogether, refreshingly pragmatic, truly German, straightforward and good.

We love challenges

Our all-round competence is reflected in our tried and tested standard products that can be delivered at short notice ex-factory. But also in our individual custom-made solutions manufactured in small volumes. Consequently, we are a competent partner and, when the need arises, a flexible manufacturer of niche products, developed and designed in cooperation with our customers.

ASA Schalttechnik proudly stands for this philosophy and delivers every time. As a family-owned enterprise, our products offer quality “Made in Germany”.

Our product range

Mechanical, magnetic and electronic switchgear for machinery and plant engineering – control and automation technology, fire protection technology, medical technology and much more:

- Limit Switches
- Switchgear
- Foot Switches
- Safety Switches
- Medical switching devices
- Magnetic Switches
- Level Switches
- Special switching devices



Quality is a continuous process

Or to put it another way, it's a never-ending process – an infinite cycle of testing, analysing, understanding, learning, optimising and documenting. That's life. Our suppliers also support us with this process, as it's the only way to make quality management work. And we make sure to adhere to it: With staying power since 1975.

Environmental protection is a point of honour

Save electricity, water and heating energy. Avoid waste and plan responsible use of raw materials in production. For our team, ecology is not just hype – it plays an important part in our day-to-day operations, also with regard to RoHS, REACH and recycling. Beneficial to nature, beneficial to us all.

It's the team that makes the difference

ASA Schalttechnik: People who achieve – hands-on people who think for themselves and who inspire us with their energy, ideas and experience. Whether they work in our production department, in customer relations or in management, our committed staff does everything to achieve best prices, top-of-class products, best delivery times and excellent services. And that's a promise!



 **made**
 **in**
 **Germany**

ASA foot switches

ASA foot switches

Ranging from standard switchgear to special designs: ASA foot switches are used in industry and also in medical applications. With a great deal of success wherever operators have to keep their hands free and trigger processes with their foot.

Stable, non-slip, ideal

ASA foot switches are functional, safe and made from high-quality materials. Mechanical stability and modern industrial design are combined and the flexible switch lines offer a suitable model for every application.



Ease of operation and precision

- Many power levels and different switching systems.
- Housings, switch inserts and pedal functions also available in especially sturdy versions – for intensive industrial use.
- The pedal surfaces are especially non-slip and designed flat for safety and ergonomics.
- Of course they are RoHS-compliant.

Please also note the technical details on the following pages.

Foot switch lines – overview:

FM – FK – FL – FS

The FM line includes miniature foot switches

- FM1** Plastic foot switch, miniature design, 1-pedal, no foot guard
- FM1...U** Plastic foot switch, miniature design, 1-pedal, with foot guard
- FM2** Plastic foot switch, miniature design, 2-pedal, no foot guard
- FM3** Plastic foot switch, miniature design, 3-pedal, no foot guard

The FK line includes small foot switches

- FK1** Plastic foot switch, small design, 1-pedal, no foot guard
- FK1...U** Plastic foot switch, small design, 1-pedal, with foot guard

The FL line includes lightweight foot switches

- FL1** Plastic foot switch, lightweight design, 1-pedal, no foot guard
- FL1...U** Plastic foot switch, lightweight design, 1-pedal, with cast aluminium foot guard

The FS line includes heavy foot switches

- FS1** Cast aluminium foot switch, heavy design, 1-pedal, no foot guard
- FS1...U** Cast aluminium foot switch, heavy design, 1-pedal, with cast aluminium foot guard
- FS2** Cast aluminium foot switch, heavy design, 2-pedal, no foot guard
- FS2...U** Cast aluminium foot switch, heavy design, 2-pedal, with cast aluminium foot guard
- FS3** Cast aluminium foot switch, heavy design, 3-pedal, no foot guard
- FS3...U** Cast aluminium foot switch, heavy design, 3-pedal, with cast aluminium foot guard

The individual product lines offered by ASA include a wide selection of other switch designs. Can't find a standard solution to match your individual requirements? We look forward to discussing your needs and providing customised special configurations.

ASA foot switches

Additional pedal functions

Latching function element R

Many foot switches have a momentary contact function. When the pedal is depressed, this triggers a machine function, which is switched off again when pressure is removed from the pedal. However, to fulfill other requirements we offer an additional element so that the function remains switched on when the pedal is depressed once. The function is switched off only when the pedal is depressed again. This is achieved with a latching function element.

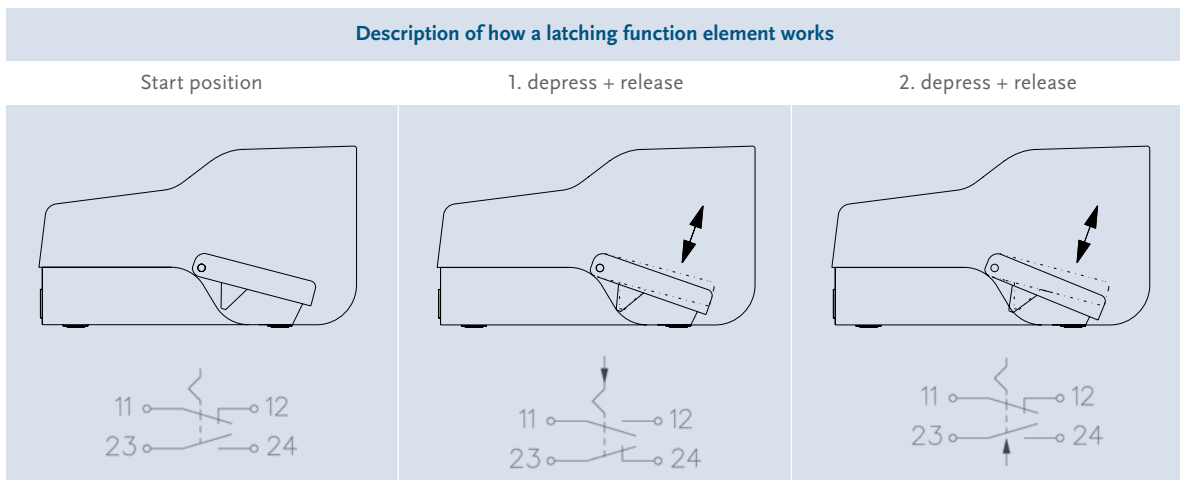

Pressure point D

Foot switches with a pressure point have a dual function. When the pedal is depressed to the very obvious pressure point, the first contact is switched (machine in ready mode). When the pedal is depressed past the pressure point, a second contact is switched and the first one remains switched (machine starts). If the pedal is now released, the two contacts are switched off in the reverse order.

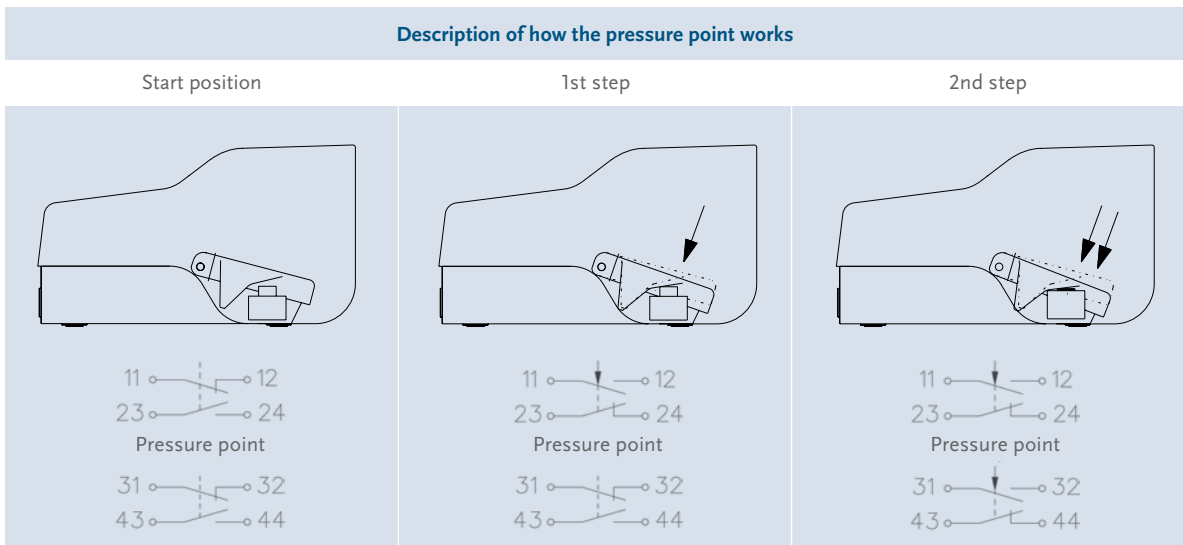

Protection options

Anti-trip lever mechanism S

If a foot switch is depressed accidentally, it can have serious consequences for plant and equipment. Accidental triggering can be prevented by a foot switch with a lever. It consists of a high-grade cast aluminium alloy that functions as a safety device. The pedal of the foot switch can be depressed only when the lever is pressed back with the tip of the foot. When the pedal is released, the lever straightens up again automatically.



Description of how the anti-trip lever mechanism works

press back

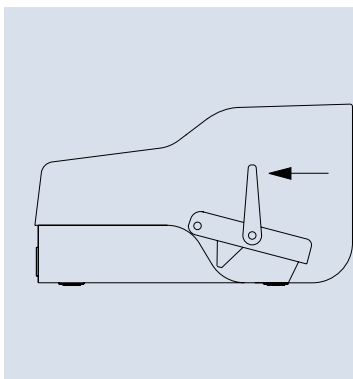

depress

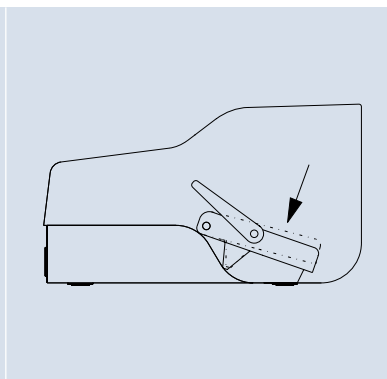

straightens up automatically

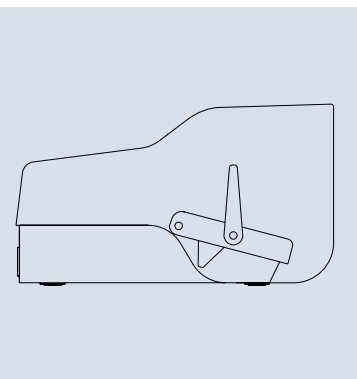

FM foot switches

Foot switches in the FM line

ASA foot switches in the FM line are miniature plastic foot switches. They are used in device and equipment engineering and also in medical applications. They are characterised by their sturdy construction, technical versatility, functionality and ergonomic design. Switches in the FM line provide maximum functions within a small area. For example, one pedal can activate two switch inserts – also in two steps with a pressure point or via a latching function.

Type key for FM line, standard designs

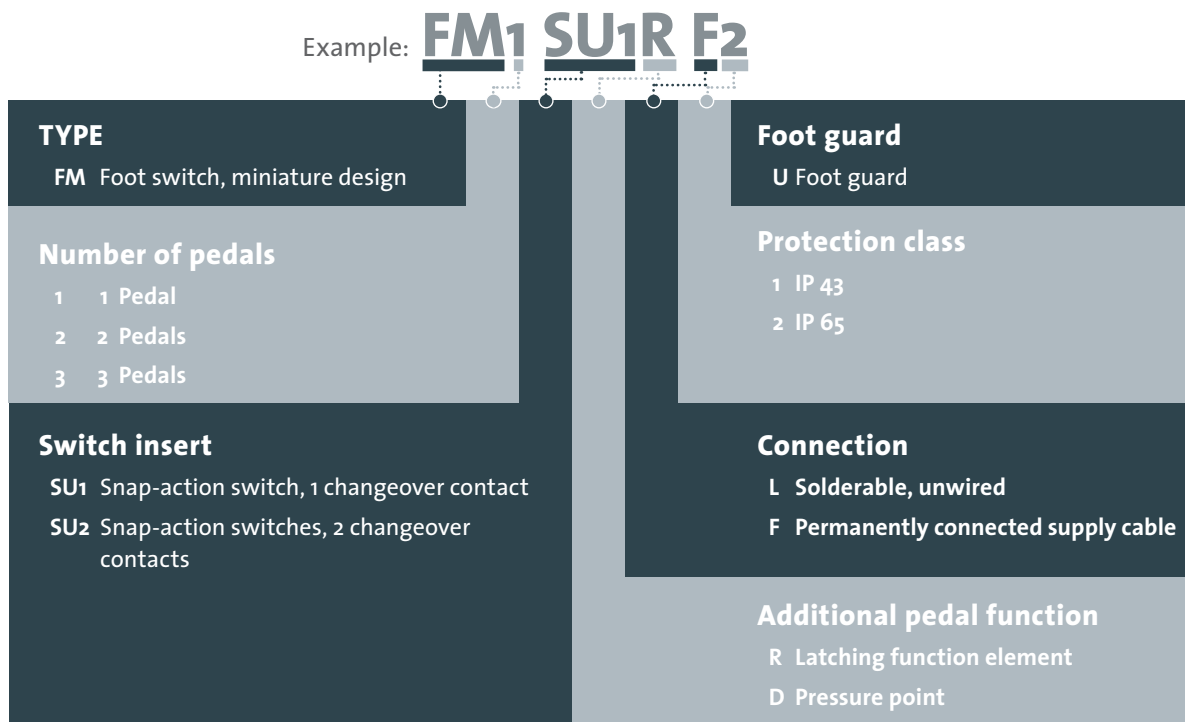

Technical specifications for foot switches in the FM line

Regulations:	ASA foot switches are manufactured in accordance with the applicable regulations IEC/EN 60204 and IEC/EN 60947-5-1.
Design:	1, 2 and 3-pedal plastic foot switch, miniature design, free-standing on non-slip elastic feet or fixed by screws from below. Multi-pedal versions on request.
Housing:	Thermoplastic PA 6.6 glass fibre-reinforced, black grey. More colours on request.
Pedal:	Thermoplastic PA 6.6 glass fibre-reinforced, black grey. More colours on request.
Top:	Thermoplastic PA 6.6 glass fibre-reinforced, black grey. More colours on request.
Foot guard:	Sheet steel, powder-coated-red RAL 3000. More colours on request.
Base plate:	Aluminium 4 mm thick, powder-coated-black grey RAL 7021. More colours on request.
Channel:	Sheet steel, powder-coated-black grey RAL 7021. More colours on request.
Connection:	<ul style="list-style-type: none"> • Solderable, unwired • PVC control cable, structure corresponds to Ho5VV-F, S=0.5 mm∞, black, length 2 m
Cable inlet:	Cable gland with protective spring coil, available as special design with protective rubber sleeve
Protection class:	IP 43 or IP 65 according to IEC/EN 60529. Higher protection classes on request.
Switching contact:	IP 54 according to DIN 40050; as special design IP 65 according to DIN 40050, with incremental
Switching function:	• Momentary • Maintained • Sequence circuit with pressure point
Switching cycles:	min. 10 million
Working temperature:	-20 °C to +80 °C, other temperature ranges on request

Switch inserts	SU1	SU2
Switch type:	1 changeover contact switch with single break	2 changeover contact switch with single break
Switching system:	Snap-action mechanism	Snap-action mechanism
Contact material:	Silver	Silver
Voltage:	max. 250 VAC, 40-60 Hz	max. 250 VAC, 40-60 Hz
Current capacity:	max. 6 A	max. 6 A
Approvals:	UL, CSA, VDE, SEV, SEMKO	UL, CSA, VDE, SEV, SEMKO

FM foot switches



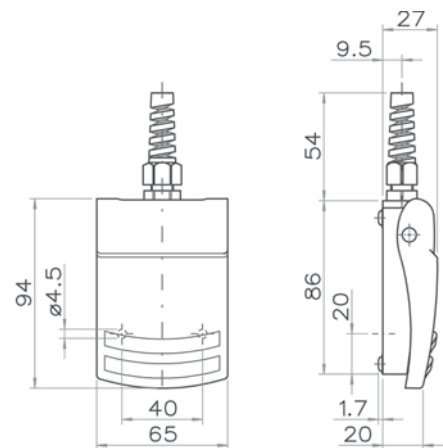

Type table for FM1 foot switches, standard selection

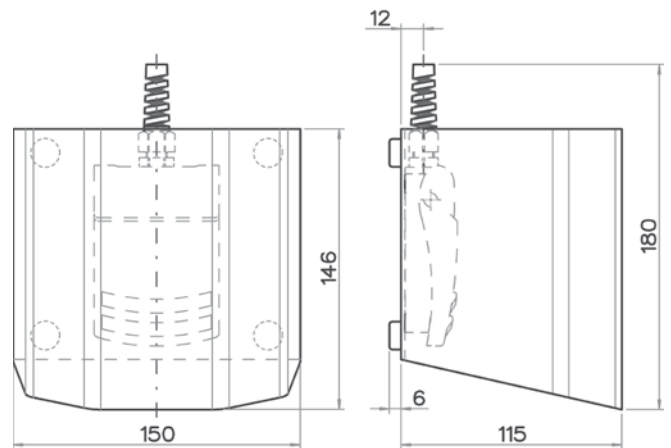

Type	No.	Contact	Switch insert per pedal	Switching system	Latching function element	Pressure point	Lever	Connection	Protection class
FM1 SU1 L1	8026 0000		SU1	Snap-action	–	–	–	Solderable	IP 43
FM1 SU1 F1	8026 0100		SU1	Snap-action	–	–	–	3 x 0.5	IP 43
FM1 SU1 F2	8026 0105		SU1	Snap-action	–	–	–	3 x 0.5	IP 65
FM1 SU1R L1	8026 0002		SU1	Snap-action	●	–	–	Solderable	IP 43
FM1 SU1R F1	8026 0102		SU1	Snap-action	●	–	–	3 x 0.5	IP 43
FM1 SU1R F2	8026 0107		SU1	Snap-action	●	–	–	3 x 0.5	IP 65
FM1 SU2 L1	8026 0001		SU2	Snap-action	–	–	–	Solderable	IP 43
FM1 SU2 F1	8026 0101		SU2	Snap-action	–	–	–	6 x 0.5	IP 43
FM1 SU2 F2	8026 0106		SU2	Snap-action	–	–	–	6 x 0.5	IP 65
FM1 SU2R L1	8026 0003		SU2	Snap-action	●	–	–	Solderable	IP 43
FM1 SU2R F1	8026 0103		SU2	Snap-action	●	–	–	6 x 0.5	IP 43
FM1 SU2R F2	8026 0108		SU2	Snap-action	●	–	–	6 x 0.5	IP 65
FM1 SU1DSU1 L1	8026 0004		2 x SU1	Snap-action	–	●	–	Solderable	IP 43
FM1 SU1DSU1 F1	8026 0104		2 x SU1	Snap-action	–	●	–	6 x 0.5	IP 43
FM1 SU1DSU1 F2	8026 0109		2 x SU1	Snap-action	–	●	–	6 x 0.5	IP 65

Type table for FM1...U foot switches, standard selection



Type	No.	Contact	Switch insert per pedal	Switching system	Latching function element	Pressure point	Lever	Connection	Protection class
FM1 SU1 L1 U	8026 0050		SU1	Snap-action	–	–	–	Solderable	IP 43
FM1 SU1 F1 U	8026 0150		SU1	Snap-action	–	–	–	3 x 0.5	IP 43
FM1 SU1 F2 U	8026 0155		SU1	Snap-action	–	–	–	3 x 0.5	IP 65
FM1 SU1R L1 U	8026 0052		SU1	Snap-action	●	–	–	Solderable	IP 43
FM1 SU1R F1 U	8026 0152		SU1	Snap-action	●	–	–	3 x 0.5	IP 43
FM1 SU1R F2 U	8026 0157		SU1	Snap-action	●	–	–	3 x 0.5	IP 65
FM1 SU2 L1 U	8026 0051		SU2	Snap-action	–	–	–	Solderable	IP 43
FM1 SU2 F1 U	8026 0151		SU2	Snap-action	–	–	–	6 x 0.5	IP 43
FM1 SU2 F2 U	8026 0156		SU2	Snap-action	–	–	–	6 x 0.5	IP 65
FM1 SU2R L1 U	8026 0053		SU2	Snap-action	●	–	–	Solderable	IP 43
FM1 SU2R F1 U	8026 0153		SU2	Snap-action	●	–	–	6 x 0.5	IP 43
FM1 SU2R F2 U	8026 0158		SU2	Snap-action	●	–	–	6 x 0.5	IP 65
FM1 SU1DSU1 L1 U	8026 0054		2 x SU1	Snap-action	–	●	–	Solderable	IP 43
FM1 SU1DSU1 F1 U	8026 0154		2 x SU1	Snap-action	–	●	–	6 x 0.5	IP 43
FM1 SU1DSU1 F2 U	8026 0159		2 x SU1	Snap-action	–	●	–	6 x 0.5	IP 65

FM foot switches



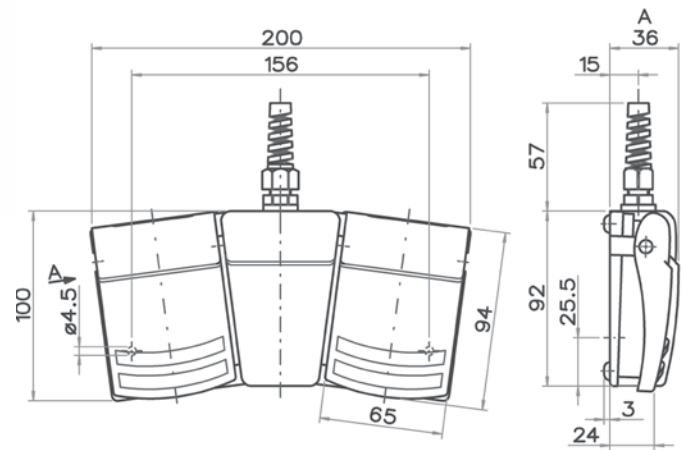



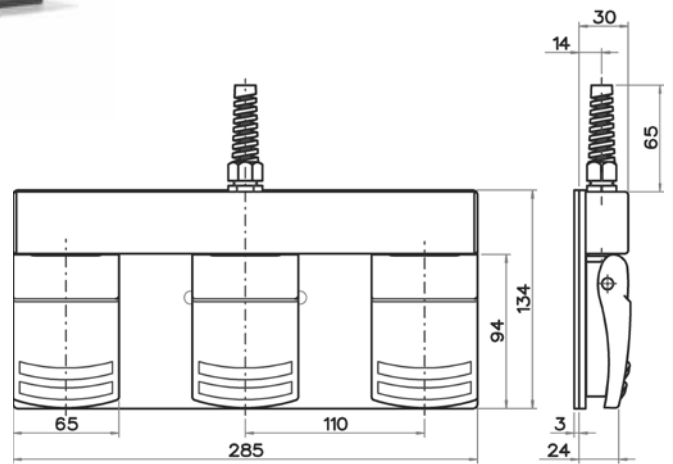

Type table for FM2 foot switches, standard selection

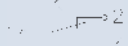

Type	No.	Contact	Switch insert per pedal	Switching system	Latching function element	Pressure point	Lever	Connection	Protection class
FM2 SU1/SU1 L1	8026 0200		SU1	Snap-action	–	–	–	Solderable	IP 43
FM2 SU1/SU1 F1	8026 0300		SU1	Snap-action	–	–	–	6 x 0.5	IP 43
FM2 SU1/SU1 F2	8026 0310		SU1	Snap-action	–	–	–	6 x 0.5	IP 65
FM2 SU1R/SU1R L1	8026 0202		SU1	Snap-action	●	–	–	Solderable	IP 43
FM2 SU1R/SU1R F1	8026 0302		SU1	Snap-action	●	–	–	6 x 0.5	IP 43
FM2 SU1R/SU1R F2	8026 0312		SU1	Snap-action	●	–	–	6 x 0.5	IP 65
FM2 SU2/SU2 L1	8026 0201		SU2	Snap-action	–	–	–	Solderable	IP 43
FM2 SU2/SU2 F1	8026 0301		SU2	Snap-action	–	–	–	12 x 0.5	IP 43
FM2 SU2/SU2 F2	8026 0311		SU2	Snap-action	–	–	–	12 x 0.5	IP 65
FM2 SU2R/SU2R L1	8026 0203		SU2	Snap-action	●	–	–	Solderable	IP 43
FM2 SU2R/SU2R F1	8026 0303		SU2	Snap-action	●	–	–	12 x 0.5	IP 43
FM2 SU2R/SU2R F2	8026 0313		SU2	Snap-action	●	–	–	12 x 0.5	IP 65
FM2 SU1DSU1/SU1DSU1 L1	8026 0204		2 x SU1	Snap-action	–	●	–	Solderable	IP 43
FM2 SU1DSU1/SU1DSU1 L1 F1	8026 0304		2 x SU1	Snap-action	–	●	–	12 x 0.5	IP 43
FM2 SU1DSU1/SU1DSU1 L1 F2	8026 0314		2 x SU1	Snap-action	–	●	–	12 x 0.5	IP 65

Type table for FM3 foot switches, standard selection



Type	No.	Contact	Switch insert per pedal	Switching system	Latching function element	Pressure point	Lever	Connection	Protection class
FM3 SU1/SU1/SU1 L1	8026 3400		SU1	Snap-action	–	–	–	Solderable	IP 43
FM3 SU1/SU1/SU1 F1	8026 3500		SU1	Snap-action	–	–	–	9 x 0.5	IP 43
FM3 SU1/SU1/SU1 F2	8026 3510		SU1	Snap-action	–	–	–	9 x 0.5	IP 65
FM3 SU1R/SU1R/SU1R L1	8026 3402		SU1	Snap-action	●	–	–	Solderable	IP 43
FM3 SU1R/SU1R/SU1R F1	8026 3502		SU1	Snap-action	●	–	–	9 x 0.5	IP 43
FM3 SU1R/SU1R/SU1R F2	8026 3512		SU1	Snap-action	●	–	–	9 x 0.5	IP 65
FM3 SU2/SU2/SU2 L1	8026 3401		SU2	Snap-action	–	–	–	Solderable	IP 43
FM3 SU2/SU2/SU2 F1	8026 3501		SU2	Snap-action	–	–	–	18 x 0.5	IP 43
FM3 SU2/SU2/SU2 F2	8026 3511		SU2	Snap-action	–	–	–	18 x 0.5	IP 65
FM3 SU2R/SU2R/SU2R L1	8026 3403		SU2	Snap-action	●	–	–	Solderable	IP 43
FM3 SU2R/SU2R/SU2R F1	8026 3503		SU2	Snap-action	●	–	–	18 x 0.5	IP 43
FM3 SU2R/SU2R/SU2R F2	8026 3513		SU2	Snap-action	●	–	–	18 x 0.5	IP 65
FM3 SU1DSU1/SU1DSU1...L1	8026 3404		2 x SU1	Snap-action	–	●	–	Solderable	IP 43
FM3 SU1DSU1/SU1DSU1...F1	8026 3504		2 x SU1	Snap-action	–	●	–	18 x 0.5	IP 43
FM3 SU1DSU1/SU1DSU1...F2	8026 3514		2 x SU1	Snap-action	–	●	–	18 x 0.5	IP 65

FK foot switches

Foot switches in the FK line

ASA foot switches in the FK line are small plastic foot switches. They are especially used in small machine and equipment engineering and also in medical applications. They are characterised by their compact design in combination with bigger, but still very flat operating pedals. The ergonomically designed housing can be fitted with one or two switch inserts – flexibility that makes it particularly attractive for many different applications. The pedal can be operated as a single switch or in two steps with a pressure point. Protection class IP 65 according to IEC/EN 60529. Note: FK foot switches are also available with three switch inserts and a foot guard – we'll be happy to advise you.

Type key for FK line, standard designs

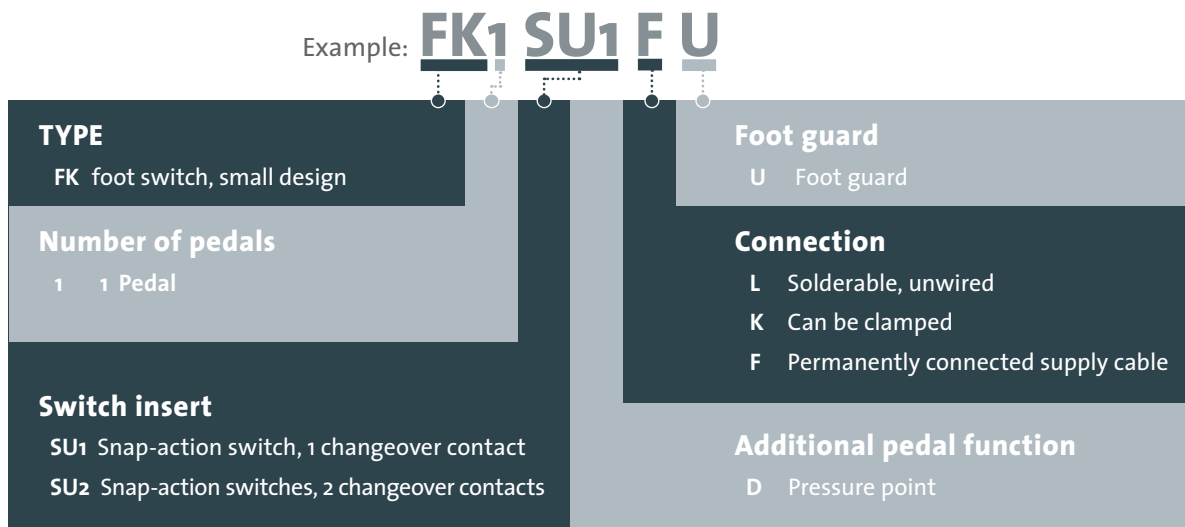

Technical specifications for foot switches in the FK line

Regulations:	ASA foot-operated switches are manufactured in accordance with the applicable regulations IEC/EN 60204 and IEC/EN 60947-5-1.
Design:	1-pedal plastic foot switch, small design, free-standing on non-slip elastic feet or fixed by screws from below.
Housing:	Thermoplastic ABS-black grey. More colours on request.
Pedal:	Thermoplastic ABS-black grey. More colours on request.
Foot guard:	Sheet steel, powder-coated-red RAL 3000. More colours on request.
Connection:	<ul style="list-style-type: none"> • Solderable, unwired • Can be clamped • PVC control cable, structure corresponds to HO5VV-F, S = 0.75 mm∞, black, length 2 mm
Cable inlet:	1 or 2 protective rubber sleeves
Protection class:	IP 43 according to IEC/EN 60529
Switching contact:	1-2 changeover contacts, simultaneous switching or sequence control. Also available as a special design with 3 changeover contacts.
Switching function:	• Momentary • Sequence circuit with pressure point
Switching cycles:	min. 10 million
Working temperature:	-20 °C to +80 °C

Switch inserts	SU1	SU2
Switch type:	1 changeover contact switch with single break	2 changeover contact switch with single break
Switching system:	Snap-action mechanism	Snap-action mechanism
Contact material:	Silver	Silver
Voltage:	max. 250 VAC, 40-60 Hz	max. 250 VAC, 40-60 Hz
Current capacity:	max. 6 A	max. 6 A
Approvals:	UL, CSA, VDE, SEV, SEMKO	UL, CSA, VDE, SEV, SEMKO

FK foot switches



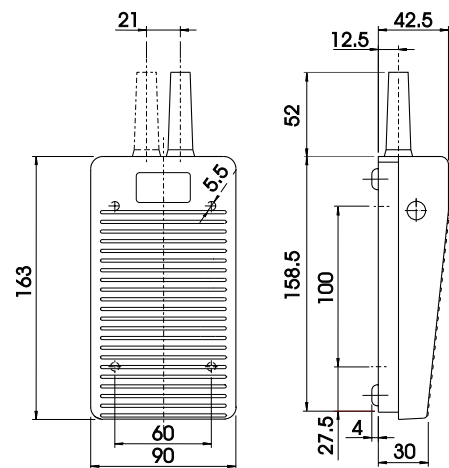

Type table for FK1 foot switches, standard selection

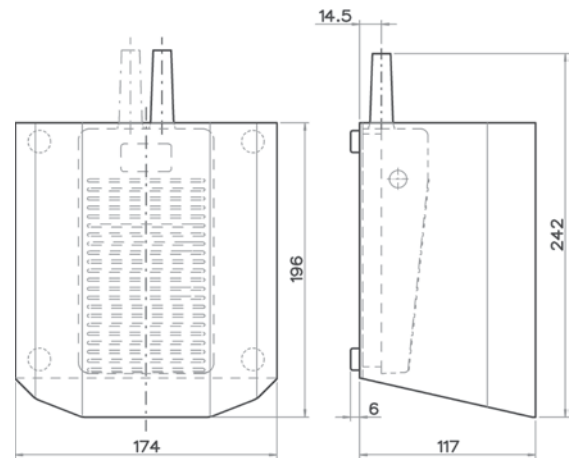

Type	No.	Contact	Switch insert per pedal	Switching system	Latching function element	Pressure point	Lever	Connection	Protection class
FK1 SU1 L	8026 0400		SU1	Snap-action	–	–	–	Solderable	IP 43
FK1 SU1 K	8026 0401		SU1	Snap-action	–	–	–	Can be clamped	IP 43
FK1 SU1 F	8026 0402		SU1	Snap-action	–	–	–	3 x 0.75	IP 43
FK1 SU2 L	8026 0403		SU2	Snap-action	–	–	–	Solderable	IP 43
FK1 SU2 K	8026 0404		SU2	Snap-action	–	–	–	Can be clamped	IP 43
FK1 SU2 F	8026 0405		SU2	Snap-action	–	–	–	6 x 0.75	IP 43
FK1 SU1DSU1 L	8026 0409		2 x SU1	Snap-action	–	●	–	Solderable	IP 43
FK1 SU1DSU1 K	8026 0410		2 x SU1	Snap-action	–	●	–	Can be clamped	IP 43
FK1 SU1DSU1 F	8026 0411		2 x SU1	Snap-action	–	●	–	6 x 0.75	IP 43

Type table for FK1...U foot switches, standard selection



Type	No.	Contact	Switch insert per pedal	Switching system	Latching function element	Pressure point	Lever	Connection	Protection class
FK1 SU1 L U	8026 0421		SU1	Snap-action	–	–	–	Solderable	IP 43
FK1 SU1 K U	8026 0422		SU1	Snap-action	–	–	–	Can be clamped	IP 43
FK1 SU1 F U	8026 0423		SU1	Snap-action	–	–	–	3 x 0.75	IP 43
FK1 SU2 L U	8026 0424		SU2	Snap-action	–	–	–	Solderable	IP 43
FK1 SU2 K U	8026 0425		SU2	Snap-action	–	–	–	Can be clamped	IP 43
FK1 SU2 F U	8026 0426		SU2	Snap-action	–	–	–	6 x 0.75	IP 43
FK1 SU1DSU1 L U	8026 0429		2 x SU1	Snap-action	–	●	–	Solderable	IP 43
FK1 SU1DSU1 K U	8026 0430		2 x SU1	Snap-action	–	●	–	Can be clamped	IP 43
FK1 SU1DSU1 F U	8026 0431		2 x SU1	Snap-action	–	●	–	6 x 0.75	IP 43

FL foot switches

Foot switches in the FL line

ASA foot switches in the FL line are large plastic foot switches. They are extremely torsion-resistant and are used for light to medium operating modes in machines and systems. They are characterised by their sturdy switch designs and versatility. All pedal function technologies can be used: One to two switch inserts with slow-action or snap-action mechanism as a simultaneous switching button, as sequence control with pressure point or with a latching function. Potentiometers may also be used. Protection options include a lever and a heavy duty foot guard made from cast aluminium alloy. The switch is manufactured with protection class IP 65 according to IEC/EN 60529 and can be used even in very rugged conditions.

Type key for FL line, standard designs

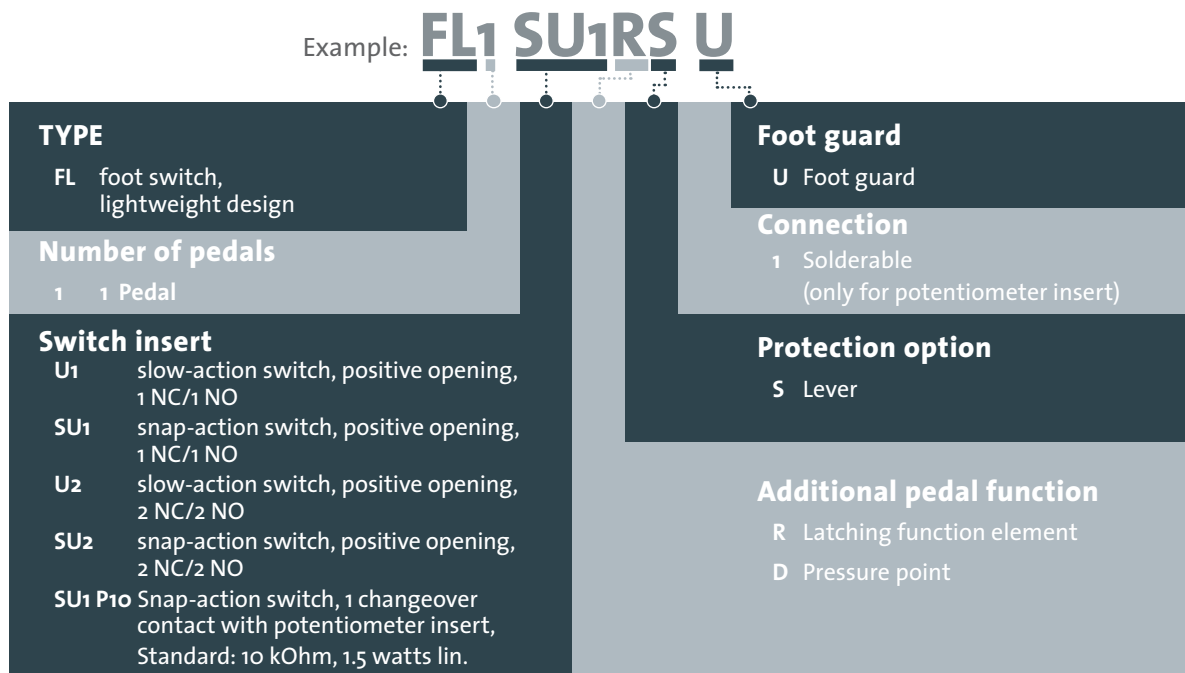





Information

The FL1 and FS1 lines can be combined. Since they have the same dimensions, the housing, pedals, top and food guard can be swapped between the models. As a result, special solutions made from plastic, aluminium and casting alloy components can become reality at a reasonable price. We'll be happy to advise you.

Technical specifications for foot switches in the FL line

Regulations:	ASA foot switches are manufactured in accordance with the applicable regulations IEC/EN 60204 and IEC/EN 60947-5-1.
Design:	1-pedal plastic foot switch, lightweight design, free-standing on non-slip elastic feet or fixed by screws from below.
Housing:	Thermoplastic PA 6.6 glass fibre-reinforced, black grey. More colours on request.
Pedal:	Thermoplastic PA 6.6 glass fibre-reinforced, black grey. More colours on request.
Top:	Aluminium die-cast, powder-coated-red RAL 3000 Hook-in fastening and two screws from above. Special design with four screws from below. More colours on request.
Food guard:	Aluminium die-cast, powder-coated-red RAL 3000 Hook-in fastening and two screws from above. Special design with four screws from below. More colours on request.
Protection option:	Cast aluminium, powder-coated-black grey RAL 7021.
Connection:	Screw-in connection
Cable inlet:	M 20x1.5
Protection class:	IP 65 according to IEC/EN 60529. Higher protection classes on request.
Switching contact:	1-2 changeover contacts, simultaneous switching or sequence control.
Switching function:	• Momentary • Maintained • Sequence circuit with pressure point
Switching cycles:	min. 10 million
Working temperature:	-20 °C to +80 °C

Switch inserts	U1/(U2)  	SU1/ (SU2)  	SU1 P10
Switch type:	1(2) NC contacts /1(2) NO contacts Dual break, positive opening	1(2) NC contacts /1(2) NO contacts Dual break, positive opening	1 changeover contact Potentiometer insert 10kOhm, lin.
Switching system:	Slow-action mechanism	Snap-action mechanism	
Contact material:	Silver	Silver	Wire resistance
Voltage:	max. 500 VAC, 40-60 Hz	max. 500 VAC, 40-60 Hz	max. 250 VAC, 40-60 Hz
Current capacity:	max. 10 A	max. 10 A	0.5 W at + 40 °C

FL foot switches



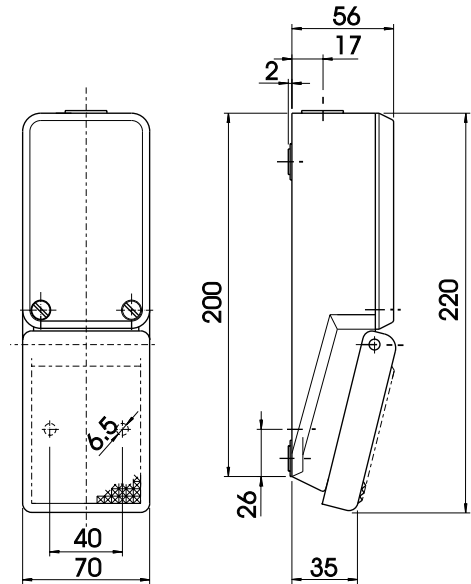





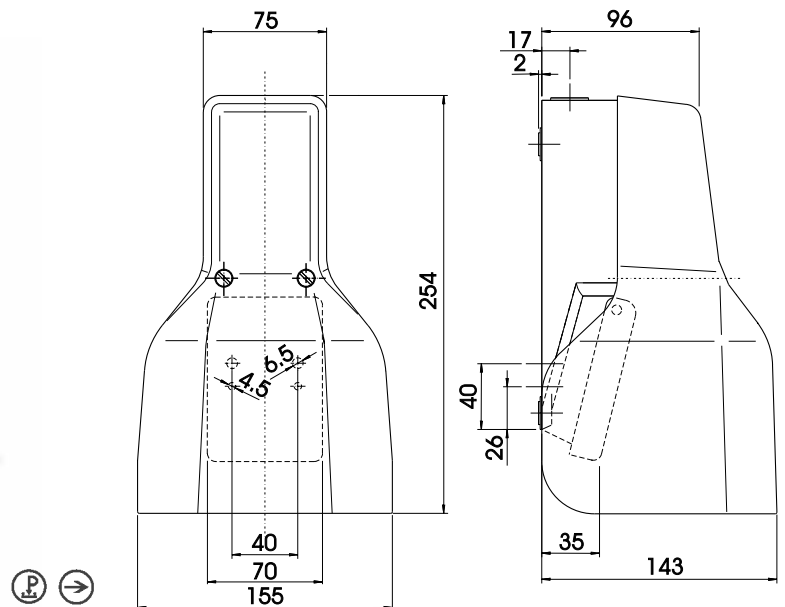







Type table for FL1 foot switches, standard selection

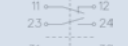

Type	No.	Contact	Switch insert per pedal	Switching system	Latching function element	Pressure point	Lever	Connection	Protection class
FL1 U1	8026 0500		U1	Slow-action	—	—	—	Can be clamped	IP 65
FL1 U1S	8026 0502		U1	Slow-action	—	—	●	Can be clamped	IP 65
FL1 U1R	8026 0501		U1	Slow-action	●	—	—	Can be clamped	IP 65
FL1 U1RS	8026 0503		U1	Slow-action	●	—	●	Can be clamped	IP 65
FL1 SU1	8026 0520		SU1	Snap-action	—	—	—	Can be clamped	IP 65
FL1 SU1S	8026 0522		SU1	Snap-action	—	—	●	Can be clamped	IP 65
FL1 SU1R	8026 0521		SU1	Snap-action	●	—	—	Can be clamped	IP 65
FL1 SU1RS	8026 0523		SU1	Snap-action	●	—	●	Can be clamped	IP 65
FL1 U2	8026 0540		U2	Slow-action	—	—	—	Can be clamped	IP 65
FL1 U2S	8026 0542		U2	Slow-action	—	—	●	Can be clamped	IP 65
FL1 U1DU1	8026 0541		2 x U1	Slow-action	—	●	—	Can be clamped	IP 65
FL1 U1DU1S	8026 0543		2 x U1	Slow-action	—	●	●	Can be clamped	IP 65
FL1 SU2	8026 0560		SU2	Snap-action	—	—	—	Can be clamped	IP 65
FL1 SU2S	8026 0562		SU2	Snap-action	—	—	●	Can be clamped	IP 65
FL1 SU1DSU1	8026 0561		2 x SU1	Snap-action	—	●	—	Can be clamped	IP 65
FL1 SU1DSU1S	8026 0563		2 x SU1	Snap-action	—	●	●	Can be clamped	IP 65
FL1 SU1 P10 L	8026 0570		SU1 P10	Snap-action	—	—	—	Solderable	IP 65

Type table for FL1...U foot switches, standard selection



Type	No.	Contact	Switch insert per pedal	Switching system	Latching function element	Pressure point	Lever	Connection	Protection class
FL1 U1 U	8026 4000		U1	Slow-action	–	–	–	Can be clamped	IP 65
FL1 U1S U	8026 4001		U1	Slow-action	–	–	●	Can be clamped	IP 65
FL1 U1R U	8026 4002		U1	Slow-action	●	–	–	Can be clamped	IP 65
FL1 U1RS U	8026 4003		U1	Slow-action	●	–	●	Can be clamped	IP 65
FL1 SU1 U	8026 4020		SU1	Snap-action	–	–	–	Can be clamped	IP 65
FL1 SU1S U	8026 4022		SU1	Snap-action	–	–	●	Can be clamped	IP 65
FL1 SU1R U	8026 4021		SU1	Snap-action	●	–	–	Can be clamped	IP 65
FL1 SU1RS U	8026 4023		SU1	Snap-action	●	–	●	Can be clamped	IP 65
FL1 U2 U	8026 4040		U2	Slow-action	–	–	–	Can be clamped	IP 65
FL1 U2S U	8026 4042		U2	Slow-action	–	–	●	Can be clamped	IP 65
FL1 U1DU1 U	8026 4041		2 x U1	Slow-action	–	●	–	Can be clamped	IP 65
FL1 U1DU1S U	8026 4043		2 x U1	Slow-action	–	●	●	Can be clamped	IP 65
FL1 SU2 U	8026 4060		SU2	Snap-action	–	–	–	Can be clamped	IP 65
FL1 SU2S U	8026 4062		SU2	Snap-action	–	–	●	Can be clamped	IP 65
FL1 SU1DSU1 U	8026 4061		2 x SU1	Snap-action	–	●	–	Can be clamped	IP 65
FL1 SU1DSU1S U	8026 4063		2 x SU1	Snap-action	–	●	●	Can be clamped	IP 65
FL1 SU1 P10 L U	8026 4070		SU1 P10	Snap-action	–	–	–	Solderable	IP 65

FS foot switches

Foot switches in the FS line

ASA foot switches in the FS line are large foot switches which, due to their extremely sturdy cast aluminium alloy, are ideal for use in the heavy manufacturing, mechanical engineering and plant construction industries as well as in the medical sector. The foot switches are sturdy, compact and extremely versatile. One to two switch inserts can be used with slow-action or snap-action mechanism as a simultaneous switching button, as sequence control with pressure point or with a latching function. Potentiometers can also be used. For additional protection, a lever, cast aluminium alloy foot guard and a pedal lock are available on request. The products are also manufactured in protection class IP 65 according to IEC/EN 60529.

Type key for FS line, standard designs

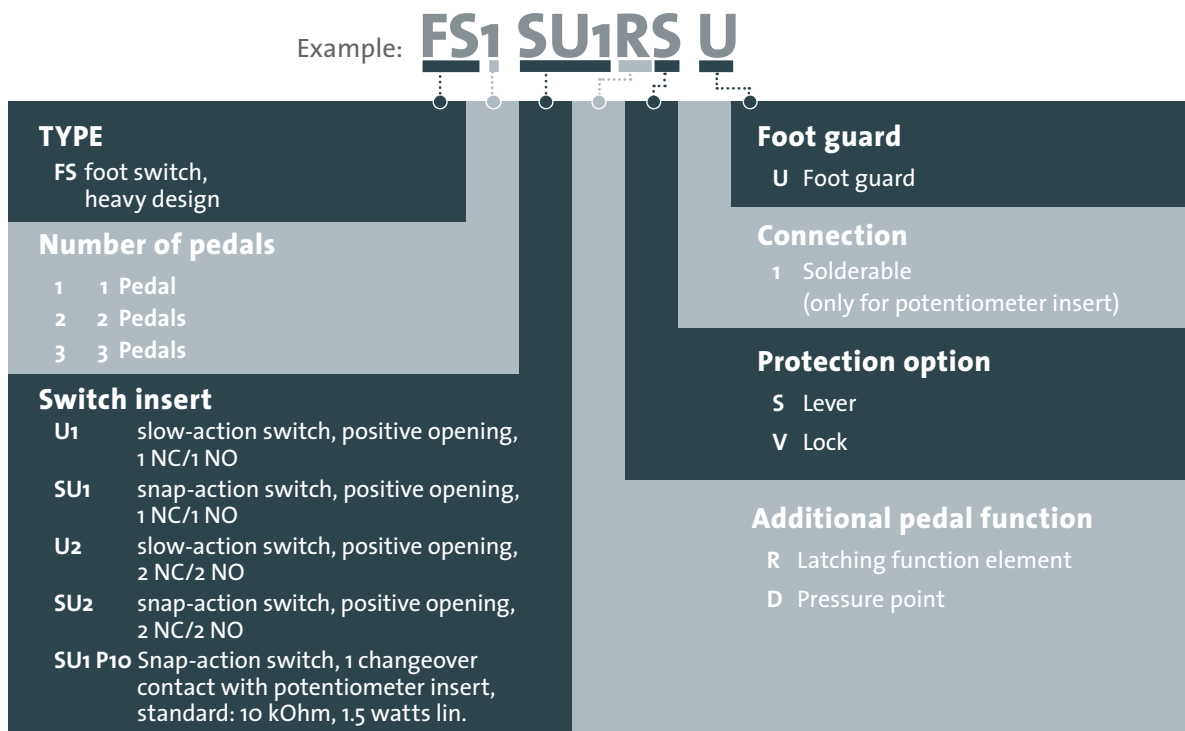





Information

The FL1 and FS1 lines can be combined. Since they have the same dimensions, the housing, pedals, top and food guard can be swapped between the models. As a result, special solutions made from plastic, aluminium and casting alloy components can become reality at a reasonable price. We'll be happy to advise you.

Technical specifications for foot switches in the FS line

Regulations:	foot switches are manufactured in accordance with the applicable regulations IEC/EN 60204 and IEC/EN 60947-5-1.
Design:	1, 2 and 3-pedal aluminium foot switch, heavy design, free-standing on non-slip elastic feet or fixed by screws from below.
Housing:	Aluminium die-cast alloy, powder-coated-black grey RAL 7021. More colours on request.
Pedal:	PA 6.6 glass fibre-reinforced, black grey. As a special design, aluminium die-cast alloy, powder-coated-black grey RAL 7021. More colours on request.
Top:	Aluminium die-cast, powder-coated-red RAL 3000 Hook-in fastening and two screws from above. Special design with four screws from below. More colours on request.
Foot guard:	Aluminium die-cast, powder-coated-red RAL 3000 Hook-in fastening and two screws from above. Special design with four screws from below. More colours on request.
Lever:	Cast aluminium, powder-coated-black grey RAL 7021.
Connection:	Screw-in connection
Cable inlet:	M 20x 1.5
Protection class:	IP 65 according to IEC/EN 60529 Higher protection classes on request.
Switching contact:	1-2 changeover contacts, simultaneous switching or sequence control.
Switching function:	• Momentary • Maintained • Sequence circuit with pressure point
Switching cycles:	min. 10 million
Working temperature:	-30 °C to +80 °C

Switch inserts	U ₁ /(U ₂)  	SU ₁ /(SU ₂)  	SU1 P10
Switch type:	1(2) NC contacts /1(2) NO contacts, Dual break, positive opening	1(2) NC contacts /1(2) NO contacts, Dual break, positive opening	1 changeover contact Potentiometer insert 10 kOhm, lin.
Switching system:	Slow-action mechanism	Snap-action mechanism	
Contact material	Silver	Silver	Wire resistance
Voltage	max. 500 VAC, 40-60 Hz	max. 500 VAC, 40-60 Hz	max. 250 VAC, 40-60 Hz
Current capacity:	max. 10 A	max. 10 A	0.5 W at +40 °C

FS foot switches



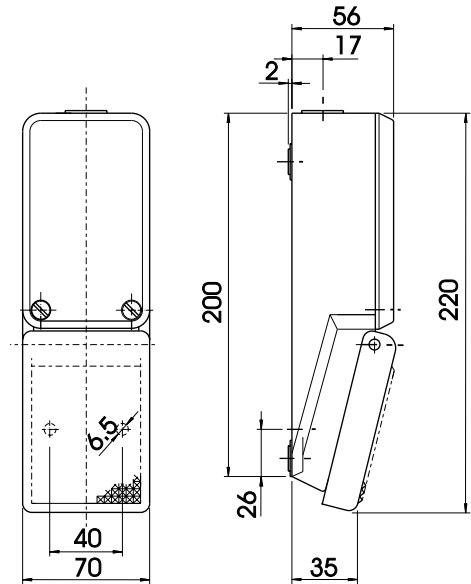





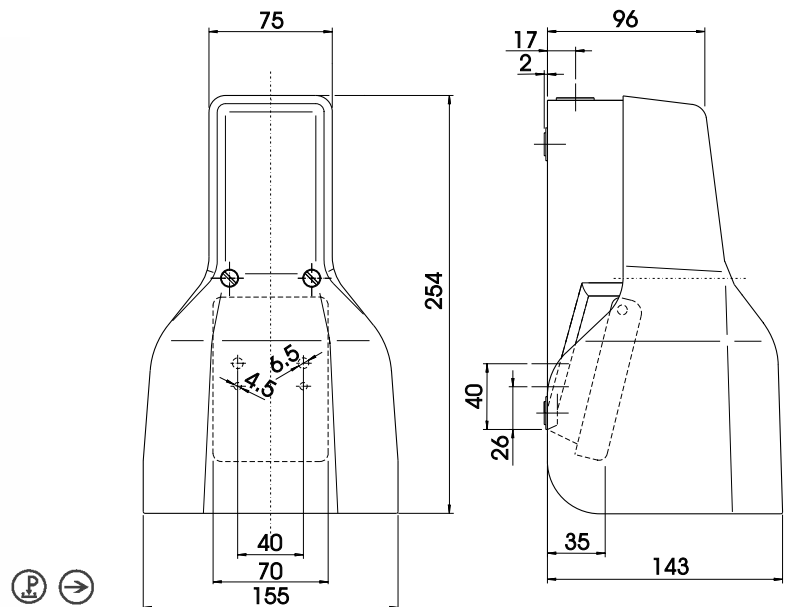







Type table for FS1 foot switches, standard selection

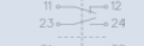

Type	No.	Contact	Switch insert per pedal	Switching system	Latching function element	Pressure point	Lever	Connection	Protection class
FS1 U1	8026 0600		U1	Slow-action	—	—	—	Can be clamped	IP 65
FS1 U1S	8026 0602		U1	Slow-action	—	—	●	Can be clamped	IP 65
FS1 U1R	8026 0601		U1	Slow-action	●	—	—	Can be clamped	IP 65
FS1 U1RS	8026 0603		U1	Slow-action	●	—	●	Can be clamped	IP 65
FS1 SU1	8026 0620		SU1	Snap-action	—	—	—	Can be clamped	IP 65
FS1 SU1S	8026 0622		SU1	Snap-action	—	—	●	Can be clamped	IP 65
FS1 SU1R	8026 0621		SU1	Snap-action	●	—	—	Can be clamped	IP 65
FS1 SU1RS	8026 0623		SU1	Snap-action	●	—	●	Can be clamped	IP 65
FS1 U2	8026 0640		U2	Slow-action	—	—	—	Can be clamped	IP 65
FS1 U2S	8026 0642		U2	Slow-action	—	—	●	Can be clamped	IP 65
FS1 U1DU1	8026 0641		2 x U1	Slow-action	—	●	—	Can be clamped	IP 65
FS1 U1DU1S	8026 0643		2 x U1	Slow-action	—	●	●	Can be clamped	IP 65
FS1 SU2	8026 0660		SU2	Snap-action	—	—	—	Can be clamped	IP 65
FS1 SU2S	8026 0662		SU2	Snap-action	—	—	●	Can be clamped	IP 65
FS1 SU1DSU1	8026 0661		2 x SU1	Snap-action	—	●	—	Can be clamped	IP 65
FS1 SU1DSU1S	8026 0663		2 x SU1	Snap-action	—	●	●	Can be clamped	IP 65
FS1 SU1 P10 L	8026 0670		SU1 P10	Snap-action	—	—	—	Solderable	IP 65

Type table for FS1...U foot switches, standard selection



Type	No.	Contact	Switch insert per pedal	Switching system	Latching function element	Pressure point	Lever	Connection	Protection class
FS1 U1 U	8026 0680		U1	Slow-action	–	–	–	Can be clamped	IP 65
FS1 U1S U	8026 0682		U1	Slow-action	–	–	●	Can be clamped	IP 65
FS1 U1R U	8026 0681		U1	Slow-action	●	–	–	Can be clamped	IP 65
FS1 U1RS U	8026 0683		U1	Slow-action	●	–	●	Can be clamped	IP 65
FS1 SU1 U	8026 0720		SU1	Snap-action	–	–	–	Can be clamped	IP 65
FS1 SU1S U	8026 0722		SU1	Snap-action	–	–	●	Can be clamped	IP 65
FS1 SU1R U	8026 0721		SU1	Snap-action	●	–	–	Can be clamped	IP 65
FS1 SU1RS U	8026 0723		SU1	Snap-action	●	–	●	Can be clamped	IP 65
FS1 U2 U	8026 0760		U2	Slow-action	–	–	–	Can be clamped	IP 65
FS1 U2S U	8026 0762		U2	Slow-action	–	–	●	Can be clamped	IP 65
FS1 U1DU1 U	8026 0761		2 x U1	Slow-action	–	●	–	Can be clamped	IP 65
FS1 U1DU1S U	8026 0763		2 x U1	Slow-action	–	●	●	Can be clamped	IP 65
FS1 SU2 U	8026 0765		SU2	Snap-action	–	–	–	Can be clamped	IP 65
FS1 SU2S U	8026 0767		SU2	Snap-action	–	–	●	Can be clamped	IP 65
FS1 SU1DSU1 U	8026 0766		2 x SU1	Snap-action	–	●	–	Can be clamped	IP 65
FS1 SU1DSU1S U	8026 0768		2 x SU1	Snap-action	–	●	●	Can be clamped	IP 65
FS1 SU1 P10 L U	8026 0770		SU1 P10	Snap-action	–	–	–	Solderable	IP 65

FS foot switches



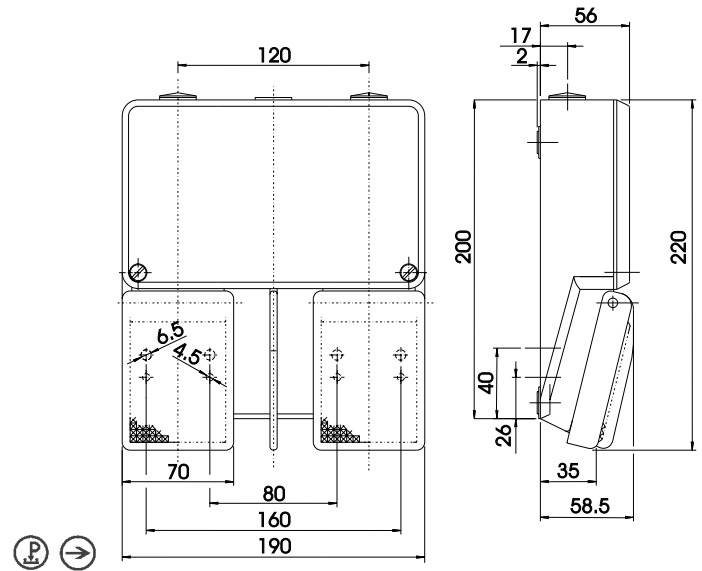





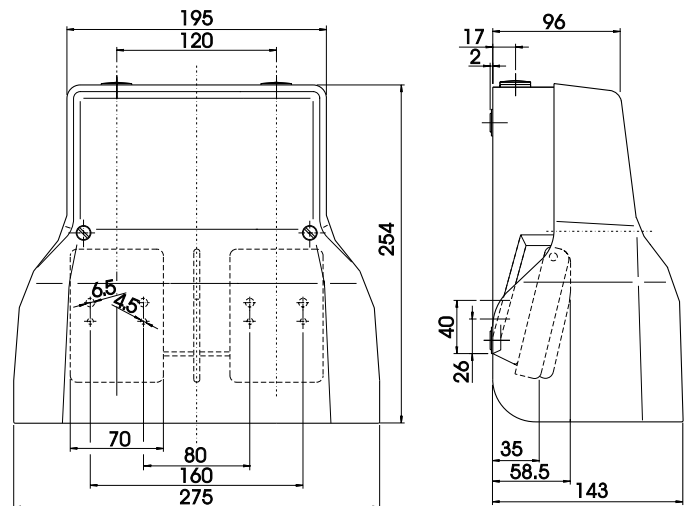







Type table for FS2 foot switches, standard selection



Type	No.	Contact	Switch insert per pedal	Switching system	Latching function element	Pressure point	Lever	Connection	Protection class
FS2 U1/U1	8026 0800		U1	Slow-action	—	—	—	Can be clamped	IP 65
FS2 U1S/U1S	8026 0802		U1	Slow-action	—	—	●	Can be clamped	IP 65
FS2 U1R/U1R	8026 0801		U1	Slow-action	●	—	—	Can be clamped	IP 65
FS2 U1RS/U1RS	8026 0803		U1	Slow-action	●	—	●	Can be clamped	IP 65
FS2 SU1/SU1	8026 0820		SU1	Snap-action	—	—	—	Can be clamped	IP 65
F2 SU1S/SU1S	8026 0822		SU1	Snap-action	—	—	●	Can be clamped	IP 65
FS2 SU1R/SU1R	8026 0821		SU1	Snap-action	●	—	—	Can be clamped	IP 65
FS2 SU1RS/SU1RS	8026 0823		SU1	Snap-action	●	—	●	Can be clamped	IP 65
FS2 U2/U2	8026 0840		U2	Slow-action	—	—	—	Can be clamped	IP 65
FS2 U2S/U2S	8026 0842		U2	Slow-action	—	—	●	Can be clamped	IP 65
FS2 U1DU1/U1DU1	8026 0841		2 x U1	Slow-action	—	●	—	Can be clamped	IP 65
FS2 U1DU1S/U1DU1S	8026 0843		2 x U1	Slow-action	—	●	●	Can be clamped	IP 65
FS2 SU2/SU2	8026 0860		SU2	Snap-action	—	—	—	Can be clamped	IP 65
FS2 SU2S/SU2S	8026 0862		SU2	Snap-action	—	—	●	Can be clamped	IP 65
FS2 SU1DSU1/SU1DSU1	8026 0861		2 x SU1	Snap-action	—	●	—	Can be clamped	IP 65
FS2 SU1DSU1S/SU1DSU1S	8026 0863		2 x SU1	Snap-action	—	●	●	Can be clamped	IP 65

Type table for FS2...U foot switches, standard selection



Type	No.	Contact	Switch insert per pedal	Switching system	Latching function element	Pressure point	Lever	Connection	Protection class
FS2 U1/U1 U	8026 0880		U1	Slow-action	–	–	–	Can be clamped	IP 65
FS2 U1S/U1S U	8026 0882		U1	Slow-action	–	–	●	Can be clamped	IP 65
FS2 U1R/U1R U	8026 0881		U1	Slow-action	●	–	–	Can be clamped	IP 65
FS2 U1RS/U1RS U	8026 0883		U1	Slow-action	●	–	●	Can be clamped	IP 65
FS2 SU1/SU1 U	8026 0920		SU1	Snap-action	–	–	–	Can be clamped	IP 65
F2 SU1S/SU1S U	8026 0924		SU1	Snap-action	–	–	●	Can be clamped	IP 65
FS2 SU1R/SU1R U	8026 0923		SU1	Snap-action	●	–	–	Can be clamped	IP 65
FS2 SU1RS/SU1RS U	8026 0926		SU1	Snap-action	●	–	●	Can be clamped	IP 65
FS2 U2/U2 U	8026 0960		U2	Slow-action	–	–	–	Can be clamped	IP 65
FS2 U2S/U2S U	8026 2002		U2	Slow-action	–	–	●	Can be clamped	IP 65
FS2 U1DU1/U1DU1 U	8026 2001		2 x U1	Slow-action	–	●	–	Can be clamped	IP 65
FS2 U1DU1S/U1DU1S U	8026 2003		2 x U1	Slow-action	–	●	●	Can be clamped	IP 65
FS2 SU2/SU2 U	8026 2020		SU2	Snap-action	–	–	–	Can be clamped	IP 65
FS2 SU2S/SU2S U	8026 2022		SU2	Snap-action	–	–	●	Can be clamped	IP 65
FS2 SU1DSU1/SU1DSU1 U	8026 2021		2 x SU1	Snap-action	–	●	–	Can be clamped	IP 65
FS2 SU1DSU1S/SU1DSU1S U	8026 2023		2 x SU1	Snap-action	–	●	●	Can be clamped	IP 65

FS foot switches



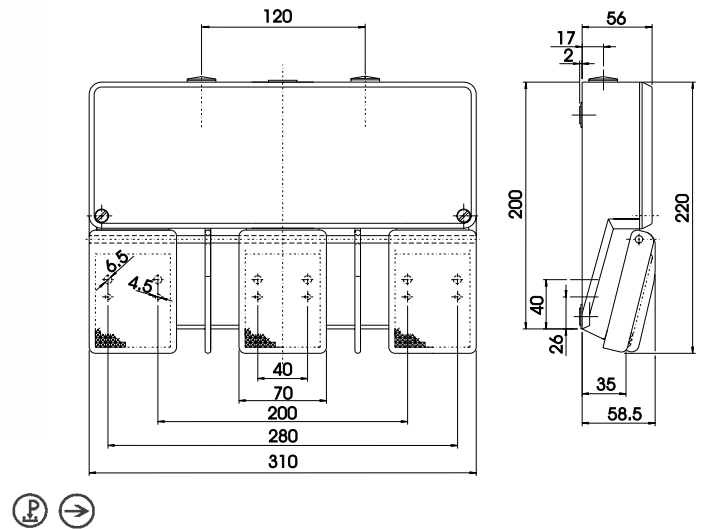





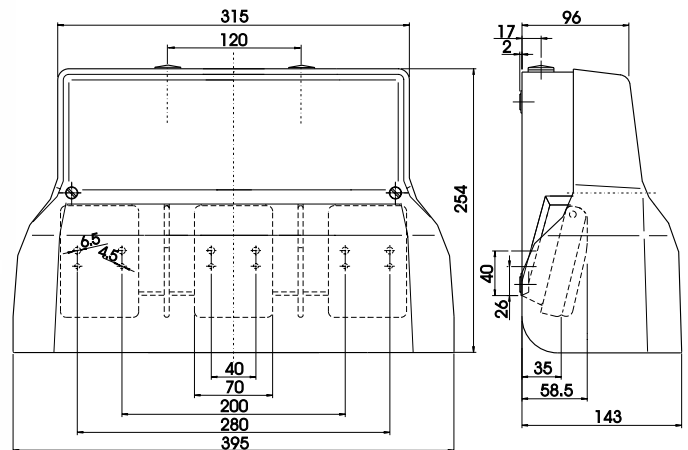







Type table for FS3 foot switches, standard selection



Type	No.	Contact	Switch insert per pedal	Switching system	Latching function element	Pressure point	Lever	Connection	Protection class
FS3 U1/U1/U1	8026 6800		U1	Slow-action	—	—	—	Can be clamped	IP 65
FS3 U1S/U1S/U1S	8026 6802		U1	Slow-action	—	—	●	Can be clamped	IP 65
FS3 U1R/U1R/U1R	8026 6801		U1	Slow-action	●	—	—	Can be clamped	IP 65
FS3 U1RS/U1RS/U1RS	8026 6803		U1	Slow-action	●	—	●	Can be clamped	IP 65
FS3 SU1/SU1/SU1	8026 6820		SU1	Snap-action	—	—	—	Can be clamped	IP 65
FS3 SU1S/SU1S/SU1S	8026 6822		SU1	Snap-action	—	—	●	Can be clamped	IP 65
FS3 SU1R/SU1R/SU1R	8026 6821		SU1	Snap-action	●	—	—	Can be clamped	IP 65
FS3 SU1RS/SU1RS/SU1RS	8026 6823		SU1	Snap-action	●	—	●	Can be clamped	IP 65
FS3 U2/U2/U2	8026 6840		U2	Slow-action	—	—	—	Can be clamped	IP 65
FS3 U2S/U2S/U2S	8026 6842		U2	Slow-action	—	—	●	Can be clamped	IP 65
FS3 U1DU1/U1DU1/U1DU1	8026 6841		2 x U1	Slow-action	—	●	—	Can be clamped	IP 65
FS3 U1DU1S/U1DU1S/U1DU1S	8026 6843		2 x U1	Slow-action	—	●	●	Can be clamped	IP 65
FS3 SU2/SU2/SU2	8026 6860		SU2	Snap-action	—	—	—	Can be clamped	IP 65
FS3 SU2S/SU2S/SU2S	8026 6862		SU2	Snap-action	—	—	●	Can be clamped	IP 65
FS3 SU1DSU1/SU1DSU1/...	8026 6861		2 x SU1	Snap-action	—	●	—	Can be clamped	IP 65
FS3 SU1DSU1S/SU1DSU1S/...	8026 6863		2 x SU1	Snap-action	—	●	●	Can be clamped	IP 65

Type table for FS3...U foot switches, standard selection



Type	No.	Contact	Switch insert per pedal	Switching system	Latching function element	Pressure point	Lever	Connection	Protection class
FS3 U1/U1/U1 U	8026 6880		U1	Slow-action	–	–	–	Can be clamped	IP 65
FS3 U1S/U1S/U1S U	8026 6882		U1	Slow-action	–	–	●	Can be clamped	IP 65
FS3 U1R/U1R/U1R U	8026 6881		U1	Slow-action	●	–	–	Can be clamped	IP 65
FS3 U1RS/U1RS/U1RS U	8026 6883		U1	Slow-action	●	–	●	Can be clamped	IP 65
FS3 SU1/SU1/SU1 U	8026 6920		SU1	Snap-action	–	–	–	Can be clamped	IP 65
FS3 SU1S/SU1S/SU1S U	8026 6924		SU1	Snap-action	–	–	●	Can be clamped	IP 65
FS3 SU1R/SU1R/SU1R U	8026 6923		SU1	Snap-action	●	–	–	Can be clamped	IP 65
FS3 SU1RS/SU1RS/SU1RS U	8026 6926		SU1	Snap-action	●	–	●	Can be clamped	IP 65
FS3 U2/U2/U2 U	8026 6960		U2	Slow-action	–	–	–	Can be clamped	IP 65
FS3 U2S/U2S/U2S U	8026 8002		U2	Slow-action	–	–	●	Can be clamped	IP 65
FS3 U1DU1/U1DU1/U1DU1 U	8026 8001		2 x U1	Slow-action	–	●	–	Can be clamped	IP 65
FS3 U1DU1S/U1DU1S/U1DU1S U	8026 8003		2 x U1	Slow-action	–	●	●	Can be clamped	IP 65
FS3 SU2/SU2/SU2 U	8026 8020		SU2	Snap-action	–	–	–	Can be clamped	IP 65
FS3 SU2S/SU2S/SU2S U	8026 8022		SU2	Snap-action	–	–	●	Can be clamped	IP 65
FS3 SU1DSU1/SU1DSU1/... U	8026 8021		2 x SU1	Snap-action	–	●	–	Can be clamped	IP 65
FS3 SU1DSU1S/SU1DSU1S/... U	8026 8023		2 x SU1	Snap-action	–	●	●	Can be clamped	IP 65

ASA foot switches

Colour? Select and request!

Our foot switches have a lot to offer and they also look great: We can customise your housings, tops and foot guards in any RAL colour of your choice. Individually coloured ASA foot switches fit harmoniously into any design. Naturally, our sales team will be happy to advise you about our attractive terms and conditions.





Key

Colour codes according to DIN IEC 757

BK	black
BN	brown
BU	blue
GY	grey
RD	red
WH	white

Other signs

-  Positive opening travel according to GS-ET-15
-  Positive opening contact